



Ace One

User Manual

Ver. 2.4

<http://www.dji-innovations.com>

©2011 Dajiang Innovation Technology Co. Ltd. All Rights Reserved.

Copyrights

This product and manual are copyrighted by Dajiang Innovation Technology Co. Ltd. with all rights reserved. No part of this product or manual shall be reproduced in any form without the prior written consent or authorization of Dajiang Innovation Technology Co. Ltd. No patent liability is assumed with respect to the use of the product or information contained herein.

©2010 Dajiang Innovation Technology Co. Ltd. All Rights Reserved.

Disclaimer

Dajiang Innovation Technology Co. Ltd. assumes no liability for damage(s) or injured incurred directly or indirectly from the use of this product.

Trademarks

DJI and Ace One are registered trademark of Dajiang Innovation Technology Co. Ltd. Names of product, brand, etc., appearing in this manual are trademarks or registered trademarks of their respective owner companies.

Product Documents List

The Ace One product package includes the following installation manual.

To correctly use Ace One system and fly safe, please read the instruction carefully before power on.

■ Warranty Card

[Warranty Card] recommend the necessary conditions for using Ace One system and related safety issues. Please fill out the customer & helicopter information card and return to DJI to register your product warranty.

■ Quick Start Guide

[Quick Start Guide] For experienced users, the quick start guide provides a brief summary of the steps that can also be found in details in the manual.

















■ Ace One User Manual

[Ace One User Manual] provides you the detailed steps for Ace One basic setup, configuration, parameter settings, operation processes, and also maintenance of the product.

Reader's Guide for This Manual

Please strictly follow these steps to mount and connect the Ace One system on your helicopter, as well as to install the Ace One Assistant software on your computer.

■ Icons seen in this document

	Forbidden		Please refer to the page(s) mentioned		R/C Transmitter configuration required		Alt Key
	Caution		Assembly & Mounting Tips		Mouse Left Click		Enter Key
	Correct		General Tips		Mouse Right Click		Up/Down/ Left/Right
	Wrong		Ace One Assistant configuration required		Ctrl Key		Directions Keys

Contents

Product Documents List	3	<i>B7</i> Engine Governor	16
Reader's Guide for This Manual	3	<i>B8</i> R/C Transmitter Calibration	17
Contents	3	<i>B9</i> SYSTEM CHECK	18
DJI Ace One Introduction	4	<i>B10</i> Autopilot	19
Package Contents	5	<i>B11</i> Camera Gimbal Control.....	20
Mounting and Connection	6	Flight	21
<i>A1</i> Before you Begin	6	<i>C1</i> Digital Compass Calibration	21
<i>A2</i> Mount the devices on your helicopter	6	<i>C2</i> MANUAL MODE Test Flight	22
<i>A3</i> Connections.....	7	<i>C3</i> Enhanced Fail-Safe	23
<i>A4</i> Ace Assistant Software Basic Operation	9	<i>C4</i> Autopilot Test Fight.....	24
Configuration Procedure	11	Maintains	26
<i>B1</i> GPS & IMU Mounting	11	Flight Log Reading	26
<i>B2</i> Control Mode Switch	12	Firmware Upgrade	26
<i>B3</i> Flybarless	13	Product Info.....	26
<i>B4</i> Swashplate	14	Appendix	27
<i>B5</i> Pitch and Throttle Curve Setup.....	14	LED Indicator description	27
<i>B6</i> Tail Gyro.....	15	Product Specifications.....	28

DJI Ace One Introduction

DJI Ace One is an autopilot system for radio-controlled helicopters, which completely takes the stress out of flying RC helicopters for both professional and hobby applications. Ace One can be installed in a variety of models, from small electric helicopters to large gasoline and turbine helicopters.

Multiple control mode based on autopilot system:

	GPS Cruise Mode	GPS Atti. Mode	Atti. Mode	Manual Mode
Command Stick Meaning	Flight speed control; Stick center position for 0m/s, its endpoint for maximum speed set by user.	Helicopter attitude control; Stick center position for 0° attitude, its endpoint for 45° which is a fixed limit.		Mechanical driving directly
Command Linearity	YES			NO
Stick Released	Lock the position when GPS signal is adequate		Only altitude stabilizing	Recommend for experience pilot only
Altitude lock	Maintain the altitude best above 3 meters			NO
Stabilization	Flybarless stabilizing on ELEV and AILE direction is available for all control mode			
GPS Lost	After 10s when GPS signal lost, System enters Atti. Mode . Automatically.		Only performing attitude stabilizing without position lock.	---
Safety	Maintain constant speed	Attitude & speed mixture control ensures stability.		Depends on experience
	Enhanced fail-safe featured, auto hover or Go-Home if transmitter signal lost			
Appropriate Applications	Long and smooth flight route	High agility for all flying		---

Built-in functions include:

- Integrated tail gyro

The flying direction (YAW) of helicopter will be effected by cross wind. Ace One system can detect the drifting angle & Speed, and control the rudder servo to eliminate such influences.

In the case of flying forward in cross-wind, Tail Gyro can work on two different modes as the example shown.

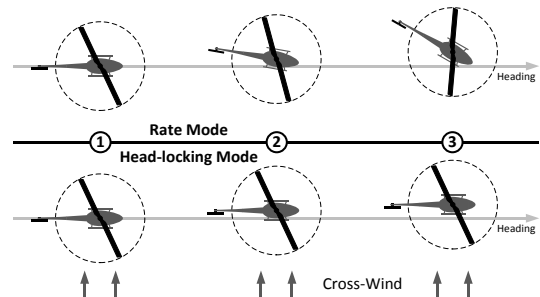

- Flybarless rotor head support
- Integrated engine governor for internal combustion engines
- Tilt and roll gimbal stabilization

Package Contents

■ Main Controller (MC)

The Main Controller is the brain of Ace One. The MC communicates with the IMU, GPS/Compass, engine governor, servos and RC transmitter to carry out autopilot functionality. The MC provides a “black box” flight log, and USB interface to read flight logs, configure Ace One and update firmware from a PC.

(System requirement: Windows XP SP3 or Windows 7)

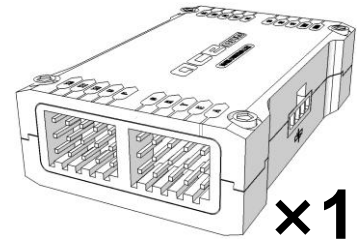

■ GPS & Compass module (GPS)

The GPS/Compass module includes two status-indicating LEDs. It should be installed on the tail boom, where there is a clear view of the sky.



■ IMU

The Inertial Measurement Unit (IMU) consists of one 3-axis accelerometer, one 3-axis gyroscope and a barometer.

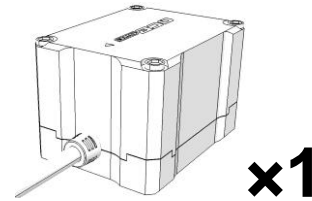

■ GPS Tail Boom Mount

The GPS Tail Boom Mount and double-sided foam tape enable secured installation for the GPS/Compass module on almost any helicopters.

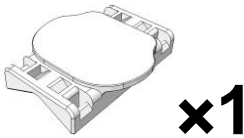

■ 3-PIN Servo Cable

Cables used to connect the MC to the RC receiver.



■ 3M 5925 Double Sided Tape

(Only for GPS & Compass module)

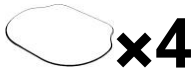

■ Micro USB Cable

This cable is used to configure Ace One, update firmware and download flight logs.

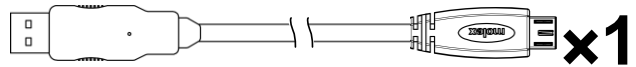

■ Quick Start Guide

For experienced users, the quick start manual provides summary of the steps which can be found in detail in this manual.

■ Warranty Card

Ace One comes with a two-year warranty, as described on this card. Please keep this for your personal records.

Mounting and Connection

A1 Before you Begin

Fly the helicopter without Ace One and make sure that the helicopter works properly without any autopilot assistance. To complete this step, you will need a tail gyro instead of Ace One system. This is a good time to isolate and resolve unwanted vibrations. **IT IS IMPORTANT THAT YOU SHOULD NOT SKIP THIS STEP.**

A2 Mount the devices on your helicopter

■ IMU

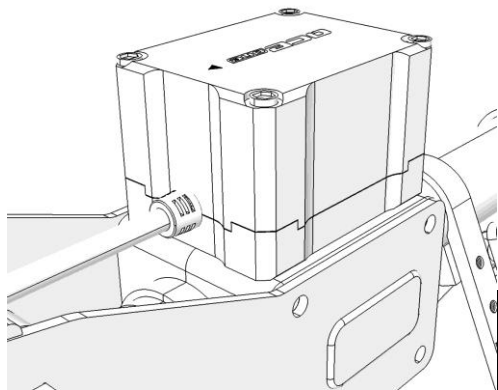

- **Where?** The IMU is best positioned near the helicopter's center of gravity, where vibration is relatively low.
- **What orientation?** Orient the IMU such that the arrow marked on the above surface of the IMU faces the sky and points directly forward, backward, left or right. The sides of the IMU should be precisely parallel to the helicopter body.
DO NOT MOUNT THE IMU UPSIDE-DOWN.
- **How?** Use double-sided foam tape for secured installation.



- 1 Check the double-sided foam tape or Velcro regularly to ensure that the IMU is securely positioned.
- 2 DO NOT cover the ventilation holes, keep them unobstructed.
- 3 The IMU module is NOT water-proof or oil-proof.

■ GPS & Compass Module (GPS)

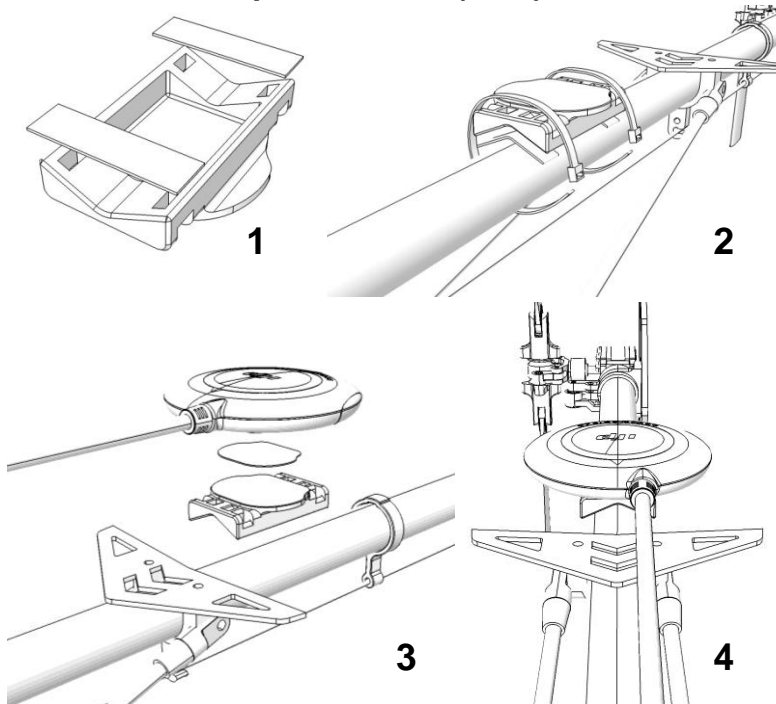

- **Where?** Mount it on the tail boom, between the rotor-head and the tail-rotor. The compass is sensitive to magnetic interference, so position the module at least 20 cm from servos and 30 cm from electric motors or gasoline (petrol) engines. The GPS is sensitive to vibration interference, so position the module at least 10 cm from the tail rotor. The GPS should not be close to the main rotor head because rotor blades can interfere with GPS satellite signal, the farther from the center of the rotor disk, the better.
- **What Orientation?** The DJI logo marked on the GPS should face the sky, with the orientation arrow pointing directly forward. The GPS is packaged with a special indication line for mounting for the first time. The LED status indicators should face the tail rotor.



- 1 If you are uncertain whether materials near the GPS are magnetic or not, you can use a compass or magnet to check it.
- 2 GPS mounting-support hardware is included in the Ace One package. If however you prefer to use your own GPS mount, please make sure that the mount material is NOT magnetic.

■ Main Controller (MC)

- **Where?** There is no orientation requirement for the MC. Maintain at least a 20-centimeter-distance between the MC and the engine or motor. Choose a mounting location where as shorter servo extension wires are needed as possible. This helps reduce the risks of electronic interference. Please also make sure the USB port is accessible when installing the MC so as to facilitate software configuration.



After choosing a location to mount the MC, it is recommended that you DO NOT mount the MC until all wirings and software configurations are completed.

A3 Connections

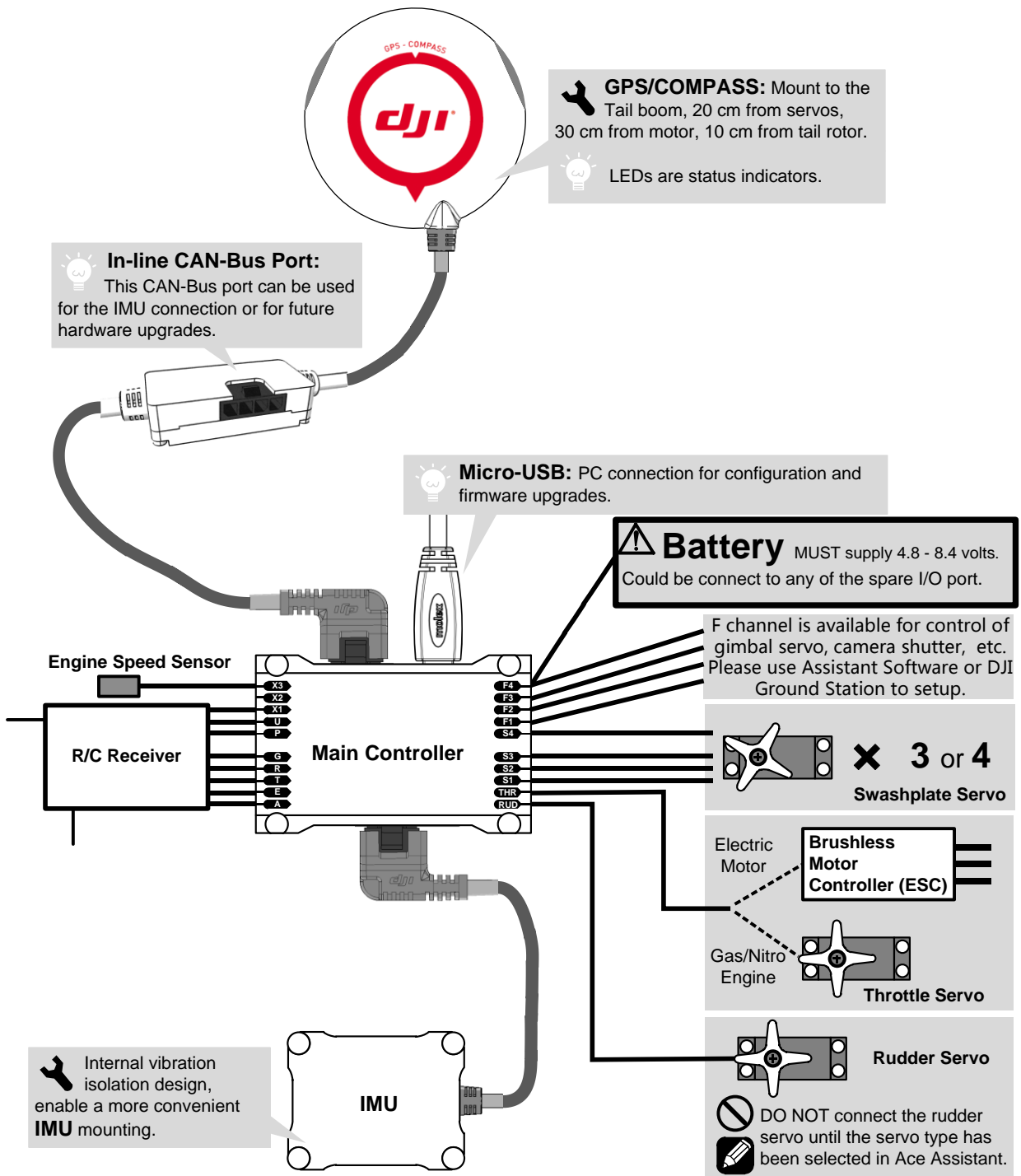

■ CAN Bus– Interface for Ace One Module

The Ace One MC uses CAN-Bus to power and communicate with other Ace One modules. Three connection ports are provided: two on the MC and one in-line connection on the GPS/Compass wire. Ace One identifies the connected devices automatically without configuration.

- GPS module can be connected to either port of MC.
- IMU can be connected to the MC or to the in-line port on the GPS wire. Connect the GPS/Compass and IMU to the MC.

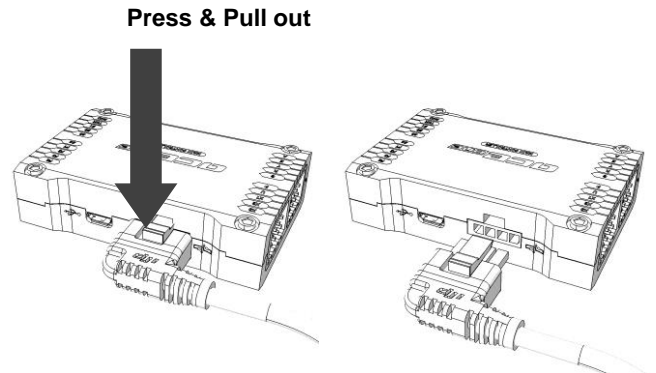

Receiver & Servos

STEP1: Set the transmitter to single-servo CCPM (Futaba: H-1; JR/Spectrum: 1sNORM; Hitec: 1-Servo 90°).

Connect the receiver to the MC input servo ports. (*High voltage receiver is essential, over 7.4v*)

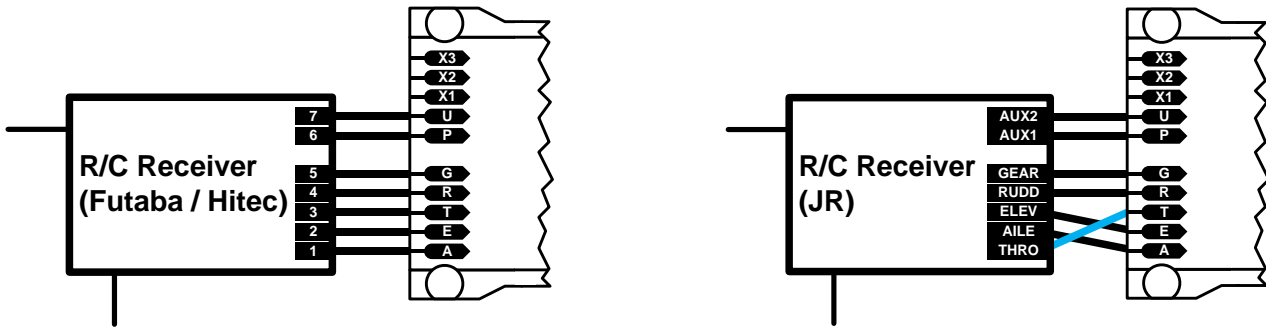

- X1** For Camera Gimbal control
- U** For Control Mode Switch
- P** For collective pitch or up/down
- G** For gyro sense adjusting
- R** For rudder control
- T** For throttle control
- E** For cyclic pitch or front/back
- A** For cyclic roll or left/right

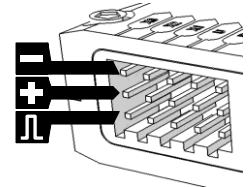

STEP2: Connect the cyclic servos and throttle servo or ESC (**NOT** the rudder servo) to the Ace One output servo ports using the diagram corresponding to the swash type of your helicopter. (*High voltage servo is essential, for example, JR HV series.*)

- S1** — **S1** — **S3** — **S4** For swashplate servos
- THR** For throttle servo or ESC
- RUD** For rudder servo
- F1** — **F2** For Gimbal servos

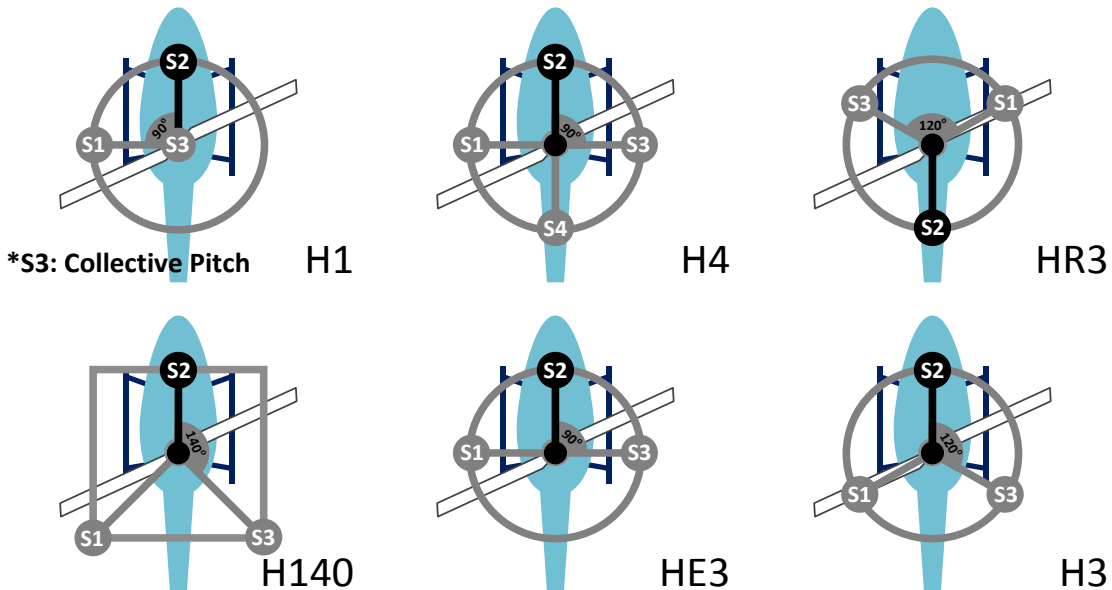
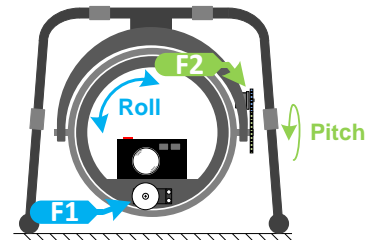

Battery or BEC

Ace One uses the same power source as the servos and receiver; power to all electronics connected to the MC can be supplied by either servo input or output ports on the MC. Ace One operates with a power source between 4.8 to 8.4 volts DC. When choosing a power source, bear in mind that all servos and Ace One will use that same power source, thus please make sure the power source you use will also satisfy the servo requirements. A high capacity battery of 4000mAh or above is strongly advised, especially for large scale electric powered helicopter.



The power consumption of Ace One is 5W maximum (testing condition: 0.9A@5V). For some small scale helicopters, the BEC provided may not be able to supply enough overall power consumption, please use high performance BEC.

A4 Ace Assistant Software Basic Operation

Software and Driver Installation

Please download and install the assistant software and driver from our website first. The micro-USB port is used for MC configuration and firmware upgrade

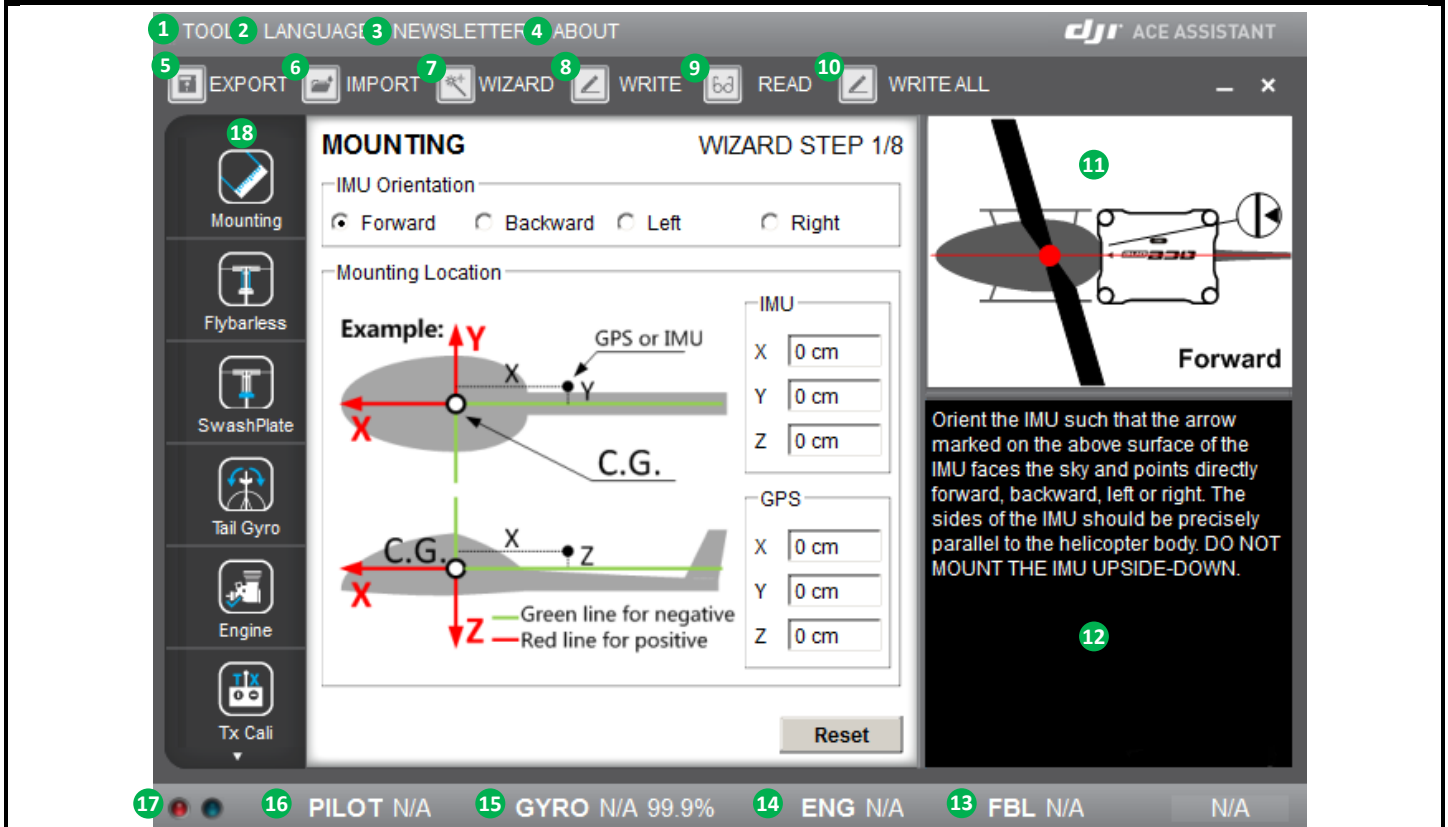

Please connect your MC to your internet enabled computer by the USB cable before you open the assistant software. You have to register at the first time you use the assistant software.

1 TOOL

- **Firmware upgrade:** update your firmware from DJI server, keep your Ace One system up-to-date.
- **Sign in:** Log onto DJI server.
- **Read flight log:** Upon choosing this, Ace One main controller will become a mobile drive under **[My computer] directory**, and Ace Assistant will be closed automatically.
- **Disable all knobs**
- **Reset to factory default**

2 Language

- a) English
- b) 中文

3 Newsletter: Latest product news.

4 ABOUT

- **Info:** Information regarding your Ace One
- **Error Code**

5 Export: export/save Ace One configurations in files.

6 Import: load previously saved Ace One configurations.

7 Wizard: step-by-step, for your first-time-configuration.

- 8 **Write:** write data of latest settings of the current page to your Ace One main controller. The parameter value or the title of which will appear as red and bold in font when modifications have been made, make sure you click the "Write" button to update your Ace One system.

9 Read: read parameters from Ace One main controller.

- 10 **Write all:** write latest settings and changes of all files to your Ace One main controller.

11 Graphic guidance

12 Text guidance

13 Flybarless function ON/OFF indication

14 Engine governor working mode indication

15 Tail gyro working mode & gyro sense indication

16 Autopilot working mode indication

17 Red light: Ace One ↔ PC has been disconnected.

Green light: Ace One ↔ PC has been connected.

Blue light: Ace One ↔ PC communication.

- 18 Here you can find all the configuration pages the same as in the "Wizard".

■ Flight & Configuration Procedure Brief



- 1 For safety reasons, during configuration and system setup, please disconnect the power supply for Electric motor.
- 2 Please do the following configurations in **Manual Mode** of the autopilot system.

Steps	Description	Page
B1 GPS & IMU Mounting	Please measure the center-of-gravity (C.G.) of your helicopter, and fill in the distance between IMU/GPS and C.G. of helicopter in X, Y & Z axes;	11
B2 Control Mode Switch	Adjust your transmitter for channel , and then you can switch the autopilot working mode between Manual / GPS Atti. / Atti. / GPS Cruise ;	12
B3 Flybarless	Please select flybarless ON/OFF. You might need to adjust parameters during test flight;	13
B4 Swashplate	Setup you swashplates according to your helicopter specification;	13
B5 Pitch & Throttle Curve Setup	Set pitch & throttle curve on your transmitter according to our suggestion;	14
B6 Tail Gyro	Make rudder correctly responding to your transmitter commands (rotating C.W. or rotating C.C.W.);	15
B7 Engine Governor	Both electric motor and gasoline engine require setting;	16
B8 R/C Transmitter Calibration	, , & are required to do;	17
B9 SYSTEM CHECK	Check controller output, IMU mounting and battery performance;	18
C1 Digital Compass Calibration	Slide the control mode switch on transmitter 10 times, and ACE ONE will enter the compass calibration mode;	21
C2 Manual Mode Test Flight	Please strictly follow the procedure during flight test, you may need to adjust the following parameters to achieve the best flight performance:	22
	B3 Flybarless control parameters if you've enabled Flybarless;	13
	B6 Tail Gyro sense;	15
	B7 Engine speed and Gov Gain for Gasoline / Nitro engine.	16
C3 Enhanced Fail-Safe	Please strictly follow the failed-safe setting procedure, otherwise this function might not be working correctly.	23
C4 Autopilot Test Fight	Please strictly follow the procedure during flight test, you may need to adjust the following parameters to achieve the best flight performance:	24
	B10 Autopilot control parameters;	19
	B3 Flybarless control parameters if you've enabled Flybarless;	13

Except tail gyro sense which is already adjustable via Tx, parameters adjusting via transmitter are also available for Flybarless and Autopilot. These parameters were indicating with "Remote Adj." option on Ace One Assistant software, which allows you adjust them from 0.5 to double times:

- INH means remote parameter adjusting was disabled;
- X1 means Remote Adj. was enabled on channel for this parameter;
- X2 means Remote Adj. was enabled on channel for this parameter.

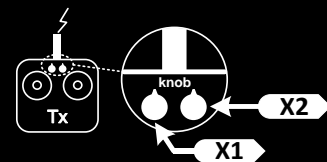

Please finish the following procedure before enable the Remote Adj:

- 1 Make sure X1 & X2 channel are connected on MC;
- 2 Assign two channels on your transmitter for channel X1 and X2;
- 3 Centered X1 & X2 knobs on transmitter, otherwise the adjustment range for increase / decrease will not be the same.

Notice: The introductions for control parameter adjustment were marked by dash-line box in this manual. You will fly the helicopter and adjust these parameters for few times during first configuration, to achieve the best flight performance.

Configuration Procedure

B1 GPS & IMU Mounting



Assistant Software - MOUNTING page

MOUNTING

WIZARD STEP 1/8

IMU Orientation **STEP1**

Forward
 Backward
 Left
 Right

Mounting Location **STEP2**

Example:

GPS or IMU

C.G.

X

Y

Z

IMU

X

Y

Z

GPS

X

Y

Z

Green line for negative

Red line for positive

STEP1: Select IMU Mounting orientation

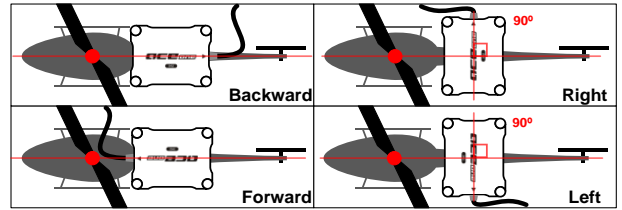

STEP2: Fill in the distance between IMU/GPS and the C.G. of helicopter in X, Y & Z axes, please measure the C.G. with following method:

- a) Adjust your helicopter, and make it balance on X and Y axle as shown below.

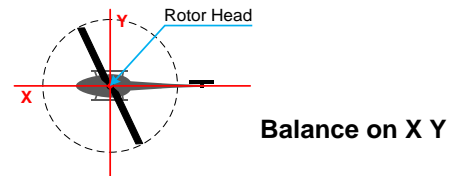

- b) The C.G. should be on the extended line of helicopter main shaft.

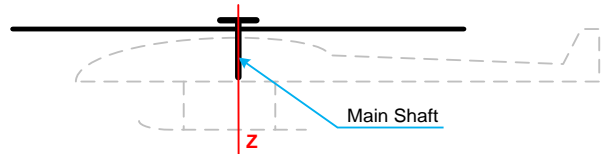

- c) Hang the helicopter by the tail and use a plum line to find C.G. on Z axle. You can use your own methods to estimate the C.G. of your helicopter.

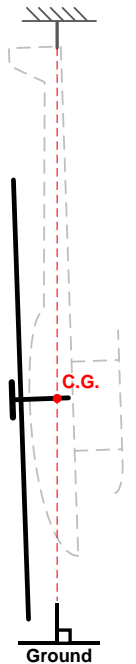

*Step c) is not required in pod/boom without camera mounted, and scale helicopter. Simply enter value zero will be sufficient.

GPS normally mounted on tail boom, thus X and Z could be zero, distance between GPS to main shaft is X.



- 1 You must re-configure if the ALL-UP-WEIGHT had been changed on your helicopter, e.g. camera mounted or battery changed.
- 2 If mounting locations are not accurate enough or the sign were wrong, error on Y, Z axle will leads helicopter vibrating, error on X axle will leads drifting during spinning.

B2 Control Mode Switch



- 1 The transmitter you used must be Fail-Safe featured, which allows you to setup fixed outputs for all channels if the receiver loses signals, otherwise Ace One will not enable the Enhanced Fail-Safe. See **Page 23** for details.
- 2 Working mode for your transmitter should be HELICOPTER.
- 3 All the channels in your transmitter should be working independently: NO CCPM, NO channel MIX , NO EXP.
- 4 You need at least one 2 or 3-position switch on your transmitter to be set as the control mode switch.



In Assistant Software, page TX-MONITOR:



Whichever 2 or 3 positions switch/channel user has

selected or decided to use in the transmitter (for control mode switching), in this case channel U marking on MC. Use sub-trim or end-point (+/-) fine tuning on your transmitter, move the slider of channel U to the specific range until Ace One Assistant indicates that it is in **Manual, GPS Cruise, GPS Atti., Atti. and Failed-Safe mode.**

Notice: To move the slider is to adjust sub-trim or end-points of the channel selected.

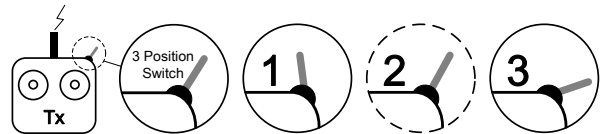

For 3-positions switch, you should assign:

Position-2 to *GPS Atti. Mode* or *Atti. Mode*;

Position-1 to *Manual Mode*;

Position-3 to *GPS Cruise Mode* or *GPS Atti. Mode*;

Or reverse the assignment for **Position-1** and **Position-3.**

For 2-positions switch, you should assign:

Position-1 to *Manual Mode*;

Position-3 to *GPS Cruise Mode* or *GPS Atti. Mode*;

Or reverse the assignment for **Position-1** and **Position-3.**

Notice: Please see page 4 for introduction of autopilot control modes.

TX MONITOR

WIZARD STEP 2,7/8

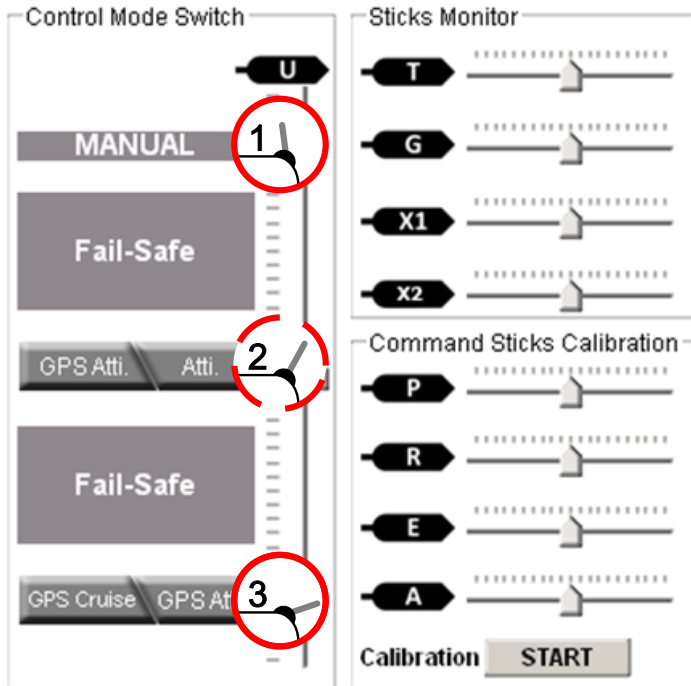

Once the switch position has been matched to specific control mode, you will see the high-light as shown following.

TX MONITOR

WIZARD STEP 2,7/8

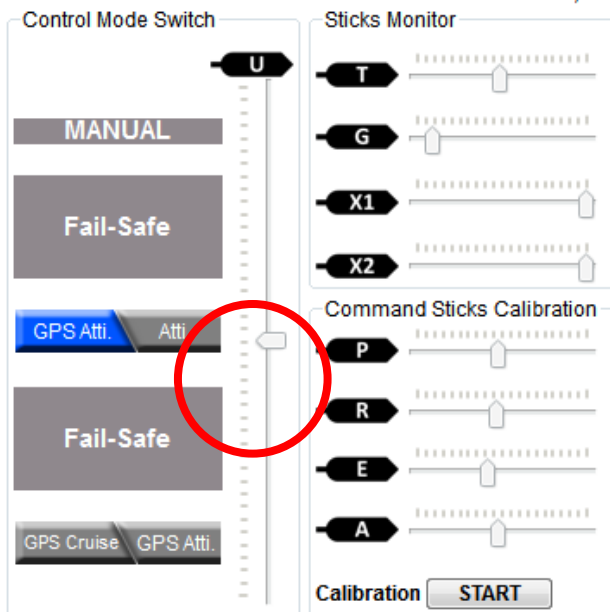

Set Fail-Safe output of receiver to input port-U, move the slider to the range which reads **Fail-Safe MODE.**

IMPORTANT: Ace One would not execute Fail-Safe protection if you don't set it properly. You can verify the Fail-Safe settings by shutting down your transmitter, and then you can use the following method to check whether Ace One was already in Fail-Safe mode.



You can check the current control mode of Ace One using either of the following methods:

- Check the Ace One Assistant status bar at the bottom side of the software interface.
- Check the LED indicators status on GPS/Compass module, see Appendix in this manual for details.

B3 Flybarless



When system is powered on, you must not move your helicopter or sticks on transmitter until the system initialization is finished (about 5 second).



Once you changed the Flybarless to "ON", the AILE and ELEV swash mix ratios in swashplate settings will be disabled, while **[Direction Reverse]** button will always be available for AILE and ELEV. After you have set the Flybarless to "ON", you have to adjust your swashplate parameters before setting your Flybarless control parameters.



- 1 You have to adjust flybarless function and test it in **Manual Mode** first.
- 2 Don't try to use **Atti. Mode, GPS Atti. Mode and GPS Cruise Mode** until you can fly flybar-less without any problems.
- 3 You might need to reduce the control gain of flybarless if you cannot make the helicopter stably hover or fly under **Atti. Mode, GPS Atti. Mode and GPS Cruise Mode**.



In Assistant Software, page-FLYBARLESS:

FLYBARLESS WIZARD STEP 4/8

Flybarless **STEP 1**

ON
 OFF

Parameter **STEP 2**

	AILE	Remote Adj.	ELEV	Remote Adj.
Gain	0%	INH ▾	0%	INH ▾
Direct Coupling	0%	INH ▾	0%	INH ▾
Turn Rate	0 deg/s		0 deg/s	
Flybar Weight	0%			0%

STEP1: Choose flybarless ON/OFF, you **MUST NOT** enable flybarless function for helicopter with flybar, otherwise the helicopter will be out of control.

When Flybarless is turned on, elevator & aileron will have stabilization in manual mode.

STEP2: During test flight procedure, please perform the following configuration procedure.

Gain Parameter range: 20% to 500%

If the helicopter is sluggish, increase it; if the helicopter oscillate back after brake, decrease it. Adjust this parameter 10% increment time until your control feeling is sharp and the helicopter would not bounce after braking.

Note: this parameter will only affect the stability but not control feeling.

Direct Input Parameter range: 30% to 300%

This is the direct connect ratio for command stick effect, the rolling speed might not be uniform if it is too high, and also will lead to quick or sudden change in cyclic response.

Cyclic Rate Parameter range: 20 deg/s to 450 deg/s

This is the helicopter body rolling speed ratio, which determines the maximum rolling speed corresponding to command stick end point. The helicopter would response very quickly if it is too high, for example high rate in 3D.

Flybar Weight Parameter range: 20% to 300%

The higher the value, the better the static stability of the helicopter. But, it will increases the sluggish on your control feeling, such as bank turn, and braking is also not sharp enough, like an large inertia helicopter. Similar to adding weight to blade tip.

■ Suggested Parameters

	ALIGN-600 Nitro (Default)		ALIGN-600 Electric		LOGO 700		Maxi Joker 3DD	
	AILE	ELEV	AILE	ELEV	AILE	ELEV	AILE	ELEV
Gain	100	100	70	90	150	160	200	250
Direct Input	100	100	120	120	160	180	240	280
Cyclic Rate	180	180	150	150	150	150	130	130
Flybar Weight	100	100	80	80	130	130	150	150

B4 Swashplate

 You should finish the setup for your swashplate in **Manual Mode**.



In Assistant Software, page-SWASHPLATE:

 If you have enabled Flybarless function, then Swash Mix ratio settings for AILE (Cyclic Roll) and ELEV (Cyclic Pitch) will not be available, please read Flybarless setting for detail.

Swash Mix is identical to Tx CCPM mixing, this function is no longer available on Tx after set to single servo (on Tx).





STEP1: You have to set the transmitter to single



servo swash (Futaba: H-1; JR/Spektrum: 1sNORM; Hitec: 1-Servo 90°), and Ace One will do the CCPM instead.

STEP2: Please make your selection according to your **swashplate type. IMPORTANT**

STEP3: The swashplate can be rotated in 360°, with 1° step increase or decrease. Not required in most conditions.

STEP4: Click   button, you can reverse the working **Direction** of swashplate servos. Servo **Trim** is in range -100 to +100, with default value at 0. The swashplate must be level. The **Current Output** will let you indicates whether your swashplate servos are on their center position or not.

 Please read your helicopter's manual, and make sure the swashplate servo linkage and all the mechanical parts were correctly adjusted before you use the above function for swashplate level adjusting.

STEP5: Click   button, you can reverse the moving direction for PITCH (Collective Pitch), AILE (Cyclic Roll) and ELEV (Cyclic Pitch).

The Swash Mix ratio is 0~100%, which defines the maximum working range for PITCH (Collective Pitch), AILE (Cyclic Roll) and ELEV (Cyclic Pitch), similar to Tx setting.

Suggestion: 35~45%, it can give you soft flying movement, and easy to configure for the following parameters.

B5 Pitch and Throttle Curve Setup

We suggest you to use the following pitch curve for better lifting power and safety descending speed.

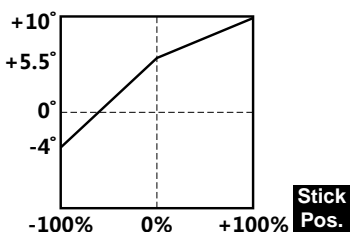

Throttle curve for electric power, this is the example for JIVE ESC:

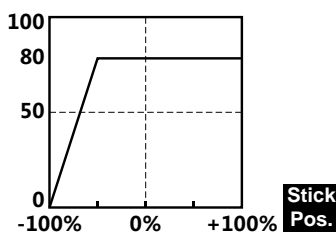

Throttle curve for integrated engine (with governor function):

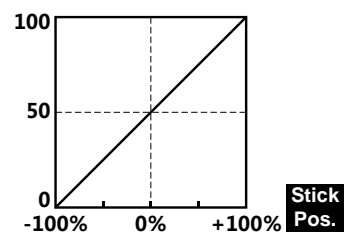

B6 Tail Gyro



When system is powered on, you must not move your helicopter or sticks on transmitter until the system initialization is finished (about 5 second).



In Assistant Software, page-Tail Gyro:

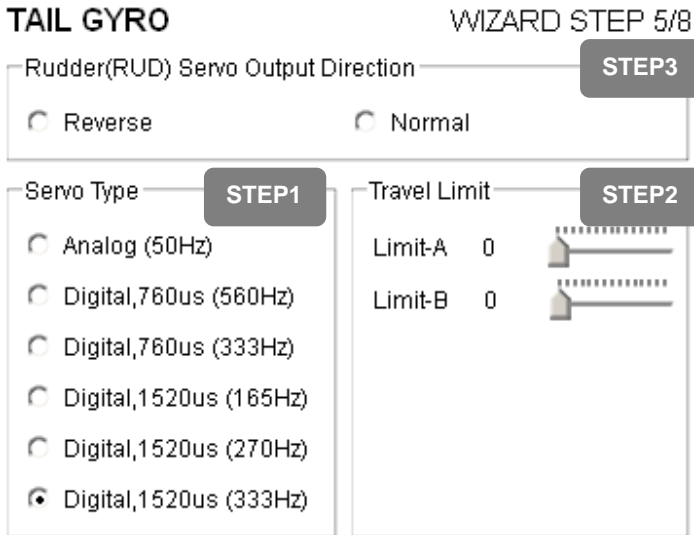

Transmitter related channels

Input	Operation	Description
R	Stick	Rudder command
G	Switch	STEP1: Gyro working mode selection: Rate Mode / Head-Locking Mode STEP2: Gyro sensitivity setting STEP3: Quickly slide it from rate mode to head-locking mode for 3 times, the command stick center position would be reset.

STEP1: Please properly set your rudder servo type before you connect your tail-gyro servo to it, otherwise your servo might be damaged due to incorrect servo type chosen.

STEP2: We have **[LimitA]** and **[LimitB]** (Range: -140 to +140), which represent end-points of the tail rotor pitch. The initial value for both is 50. Adjust these two limit value, make sure your rudder servo can work the full range for your tail rotor pitch, without any mechanical binding. Otherwise, the performance of the tail-gyro will be affected. You can identify which side of the tail rotor pitch is represented by LimitA / LimitB like this:

1. Set one of them to 0, another to 50.
2. Move your rudder stick on your transmitter.
3. One side of the tail rotor pitch will not move.
4. This side should be related to the LimitA / LimitB whichever you are giving value 0 to.

STEP3: Move your rudder stick, and check whether the tail rotor pitch is working to your expected direction. If not, please change to proper direction.



You must also finish the SYSTEM CHECK procedure in later steps, before you fly your helicopter. You might find the Controller Output Check for tail rudder result in opposite rudder moving directions, click **[Reverse]** button to make corrections. Please see **Page 18**.

G Channel Value

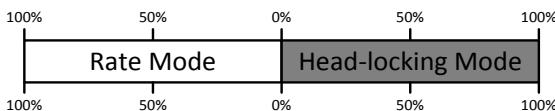

Gyro Sensitivity & Working Mode

STEP4: Switch your Tail-Gyro working mode to **[Rate Mode]**, take-off your helicopter and hover. If your helicopter drifts on YAW direction obviously, then adjust your tail servo linkage until the helicopter stops drifting. Or you can use trim to fine-tune the rudder servo.



If you used trim during the Tail-Gyro working in Rate Mode, please power off the Ace One and re-start it before you wish to use Head-Locking Mode.

STEP5: Gyro Sense setting: Set your gyro sense via transmitter, with the channel which you plug into input port-G on Ace One MC. We suggest you start from 45% in **[Head-locking mode]**, take off the helicopter, reduce the Gyro sense if tail got vibrating; if the tail response too slow and drift then increase it. Land you helicopter and switch to **[Rate mode]**, then take off the helicopter again, fine-tune the rudder servo to make the tail stop drifting and land again. Switch the tail gyro between **[rate mode]** and **[Head-locking Mode]** by 3 times, then center position of Tx will be recorded, now you finished the gyro sense setting. You can identify the Tail-Gyro working mode on the status bar of Ace One Assistant, but that gyro sense percentage may not be the same as your Tx reading due to different Tx manufacture.

B7 Engine Governor



In Assistant Software, page-ENGINE:

ENGINE WIZARD STEP 6/8

Working Mode **STEP2**

Tx Control For Electric Motor

Governor control For Gas/Nitro Engine

Throttle Servo Working Range

TEST TEST TEST **STEP3**

SET-MAX SET-IDEL SET-STOP **STEP4**

Magnetic Speed Sens **STEP5** 0%

Gov Gain **STEP7** 50%

Rotor/Engine Speed **STEP6**

Rotor RPM 800 \times Gear Ratio 10.0 = Engine RPM 6000

STEP1: Before using **Governor Control** mode, fine tune your Gas/Nitro engine to good condition. Otherwise the performance would be negatively impacted.

STEP2: Select the operation mode:

- Select **[Tx Control]** for electric motor;
- For Gas/Nitro engine, select **[Tx Control]** first, and finish next step: set throttle servo working range. Then select **[Governor Control]**.

STEP3: Set throttle servo travel range, move the throttle stick to

For Electric	For Gas/Nitro	Click to set
Maximum open position		[SET-MAX]
lowest stick throttle	Engine idling position	[SET-IDLE]
Throttle hold	Cut position	[SET-STOP]

Notice: you must not turn on the throttle-cut.

STEP4: After three of the throttle positions being set, click **[TEST]** button above to review your throttle working range settings. Throttle servo will be forced to stay on each respective position for about 2 seconds. Repeat the **[SET]** procedure if any incorrects.

If a mistake is made, e.g. **STOP** position being set between **MAX** and **IDEL**, you will be notified by (Wrong), and Engine governor will be forced to work in **[Tx Control]** mode automatically.

STEP5: A third party engine speed sensor is required for the engine speed governor to function. We suggest using Futaba magnetic engine speed sensor. You have to adjust the sensor/magnet mounting, and leave a proper space between the sensor head and magnet. You can check this with the percentage bar at page "ENGINE", over 60% means the magnet is directly facing the sensor, and less than 2% means that the sensor is far from directly pointing at the magnet.

Notice: Only ONE magnet can be mounted on cooling fans of the engine.

STEP6: Please refer to user manual of your helicopter and engine, find the following parameters:

- Main rotor speed, in range: 800 to 2500 RPM;
- main gear ratio, in range: 1.0 to 20.0;
- Engine RPM, in range: 6000 to 25000 RPM. (Will be calculated automatically)

STEP7: Gov Gain setting, range: 50% to 300%;

Suggestion: 100% for Nitro engine; 150% for gasoline engine;

The higher the gain, the higher the frequency of engine rpm fluctuation.

Governor STARTS to work in **all** of the following conditions:

- throttle stick position is higher than 20% from cut-throttle;
- When engine speed has been raised above 70% of set RPM;
- When engine speed sensor works correctly.

Governor STOPS working in **either one** of the following conditions:

- Throttle stick position lower than 10% from cut-throttle;
- Engine speed < 3000 RPM or sensor not working.

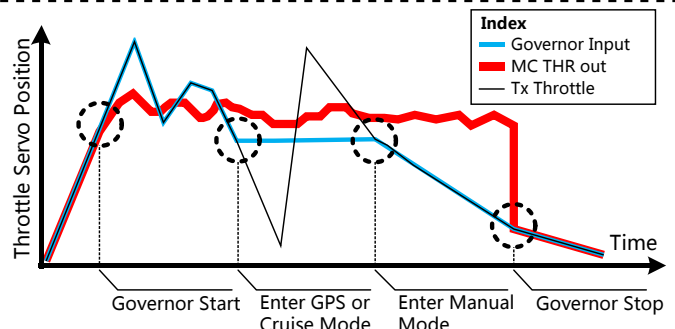

GPS Cruise, GPS Atti. and Atti. Modes take over the throttle, pitch & cyclic positions at the point of switching from **Manual mode**. It is essentially how Ace One knows to maintain throttle relative to rotor RPM, notwithstanding Go-Home function hence throttle hold other than **Manual Mode** will not cut the engine or motor. Unless, it is switched back to **Manual Mode**.

B8 R/C Transmitter Calibration



In Assistant Software, page-TX MONITOR:
WIZARD STEP 2,7/8

TX MONITOR

Control Mode Switch

MANUAL

Fail-Safe

GPS Atti. Atti.

Fail-Safe

GPS Cruise GPS Atti.

Sticks Monitor

T

G

X1

X2

Command Sticks Calibration

P

R

E

A

Calibration STA STEP1



Totally 4 TX channels are required to be calibrate:

STEP1. Click **[START]** button, and move all of the sticks throughout their complete range several times.



STEP2. Click **[FINISH]** button when you finished above procedures.



- 1 You have to finish the throttle and pitch curve setting before calibration, here the end-point of transmitter sticks will be record.
- 2 If the throttle or pitch end-point of transmitter had been changed, please calibrate it again.

B9 SYSTEM CHECK

Very important, check them carefully!



You have to run the system check in **Assistant Software – SYSTEM CHECK** for Ace One system to work properly:

■ Controller Output Check

- 1 Switch to **Non-Manual mode** first.
- 2 Click **[START]** button, Ace One will drive the **swashplate** up and down, representing collective movement during flight.
- 3 Click **[NEXT]** button, Ace One will drive the **swashplate** forward and back, representing elevator movement during flight.
- 4 Click **[NEXT]** button, Ace One will drive the **swashplate** left and right, representing aileron movement during flight.



- 5 Click **[NEXT]** button, Ace One will drive the **rudder**, representing rotating C.C.W. and then C.W.



- 6 Click **[END]** button or switch to **Manual mode**, Controller Output Check will be finished.



If the swashplate or rudder moves in opposite sequence, you should click reverse button for correction.

If the swashplate or rudder still doesn't move as you expected, it may be caused by a wrong connection between Ace One MC and R/C Receiver, please also check the swashplate setting and Tail-Gyro setting.

■ IMU Feedback Check

- 1 Switch to **Non-Manual mode** first.
- 2 Click **[CHECK]** button.
- 3 Tilt the tail boom of the helicopter, the swashplate should respond to the opposite direction.
- 4 Tilt the helicopter body on its roll direction, the swashplate should also respond to the opposite direction.
- 5 Switch to **Manual mode** and finish the IMU Feedback Check.



- 1 If your helicopter was not responding as described above, you may be placing your IMU in a wrong orientation, or you've selected a wrong orientation for your IMU in Ace One Assistant. Please check sensor mounting again.
- 2 If the swash is not level (This is not critical), this can be caused by:
 - IMU is not level to AIR frame;
 - AIR frame and landing skids are not level to ground.

■ Battery Performance Test



- 1 Switch to **Non-Manual mode** first.
- 2 Make sure that your battery has at least 80% capacity left from being fully charged.

- 1 Click **[START]** button, Ace One will force all the servos you connected and LEDs working at maximum payload, which will behave as shaking swashplate and rudder. This will continue for 20 seconds and then stop automatically, you can force it stop by clicking **[STOP]** button, or switch to **Manual mode**.

- 2 Ace One Assistant will inform you the test result (LEDs on GPS will also blink in yellow if failed condition was matched):

Failed, it means voltage drop below 3.5v, the battery or BEC were not be able to provide necessary power, please change it.

Test passed.

B10 Autopilot



In Assistant Software, page-Autopilot:

AUTOPILOT

Basic Parameters

	Gain	Remote Adj.	Max Speed Limit
Front/Back	40%	INH	10.0 m/s
Left/Right	40%	INH	10.0 m/s
Vertical	50%	INH	
Agility	50%		
Stick Delay	50%		

Advance Parameters

	Front/Back	Left/Right	Vertical
Velocity Tracking	20.0%	20.0%	20.0%
I	0%	0%	0%



Transmitter related channels

Input	Operation	Description
U	Switch	Control Mode Switch
G	Switch	Quickly slide it from rate mode to head-locking mode for 3 times, all the command sticks center position would be reset, see page 15 for tail gyro working mode setting.
P	Stick	Up/Down command from Tx
E	Stick	Front/Back command from Tx
A	Stick	Left/Right command from Tx
R	Stick	Rudder command from Tx

Suggested Parameters

	ALIGN 600 Nitro			ALIGN 600 Elec.			LOGO 700			Maxi Joker 3DD			JR GSR260		
	F/B	L/R	V	F/B	L/R	V	F/B	L/R	V	F/B	L/R	V	F/B	L/R	V
Gain	100	100	100	130	110	80	150	151	100	160	160	110	155	165	130
Agility		100			150			130			100			175	
Stick Delay		100			110			135			185			166	
Velocity Tracking	100	100	100	110	110	113	100	100	100	100	100	100	100	100	100
I	100	100	100	114	115	116	100	100	100	100	100	100	100	100	100

Base Parameters

Gain

Range: Front/back & Left/Right 40% ~ 400%; Vertical 50%~250%

If too large, you will find the helicopter oscillating in the corresponding direction (About 5~10Hz). If too small, the helicopter will likely to be hard to control.

In **GPS Atti. Mode** and **GPS Cruise Mode**, if helicopter drifting on front/back or left/right direction for 2~5 meters, then increase 10% on the corresponding direction it drifts to until the helicopter getting oscillation. If helicopter vibrate on its vertical direction, then reduce vertical parameter by 10% until it get stable. If altitude drop and drift happens during sharp braking, then increase I.D.R-Vertical in advance parameters.

MAX Speed Limit (m/s)

Range: Front/back 1.0 ~ 20.0 m/s & Left/Right 1.0 ~ 15.0 m/s

Agility

Range: 50% ~ 200%

It determines the start-up speed from command stick, the bigger the value the faster the reaction. Increase it for sharper and quicker leveling action after command stick released. The control feeling will be stiffness and rigid if the value is too high; and sluggish leveling action and slow braking if too small.

Stick Delay

Range: 50% ~ 200%

It determines the overall stick reaction speed, for example: You push your roll stick to the maximum position your helicopter will tilt from leveling to 45 degrees, the smaller the number the quicker the transition.

Advance Parameters

The default values are suitable for most of the condition, please check DJI website for details.

Velocity Tracking

Range: Front/back & Left/Right 20.0% ~ 250.0%; Vertical 20.0% ~ 150.0%

I

Range: Front/Back & Left/Right & Vertical 0% ~ 500%

B11 Camera Gimbal Control

This function aims to auto balance the 2-D camera gimbal. Roll direction of the gimbal is fully automatic controlled by Ace One, Pitch direction is automatic controlled by Ace One with real-time manual adjustment support.



In Assistant Software, page - Gimbal:

GIMBAL

Servo Travel Limit STEP1

	MAX	Center	MIN
Pitch F2	0	0	0
Roll F1	0	0	0

Automatic Control Gain STEP2

	Gain	Direction
Pitch F2	0.00	↻
Roll F1	0.00	↻

Manual Control Speed STEP4

Pitch X1	0
-----------------	---

STEP1: Servo travel limit and center position

Range: -1000 to +1000

MAX / MIN are servo travel limits; adjust them to avoid mechanical binding; Place your helicopter on level ground, adjust **CENTER** value of **PITCH** and **ROLL** direction to make the camera mounting frame to your desired angle-to-ground.

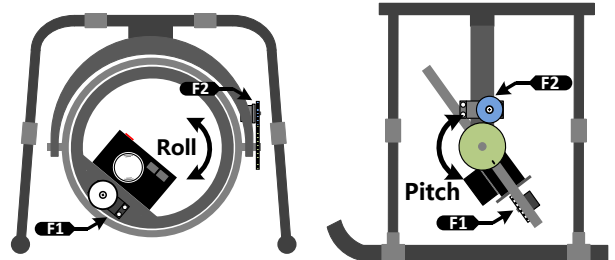

STEP2: Direction & Automatic control gain *Range: 0 to 100*

Adjust the reaction angle of automatic control, the initial value 100 is full speed ; Click ↻ / ↻ button, and then you can reverse the feedback control directions.

STEP3: Manual control command for Pitch direction of the gimbal.

You should assign one of the knobs on your transmitter to X1 channel for controlling the Pitch direction (angle) of camera gimbal during flight.

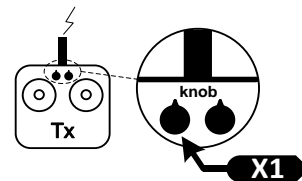

If parameter adjustment was enabled on channel X1, the gimbal manual control via channel X1 will not be force to disabled.

STEP4: Manual Control Speed

Range: 0 to 100

Adjust the reaction speed of pitch direction manual control, the initial value 100 is full speed.

C1 Digital Compass Calibration

■ Why calibrate the compass?

Ferromagnetic substances placed on helicopter or around its working environment will affect the reading of earth magnetic for digital compass, it also reduces the accuracy of the helicopter control, or even reads incorrect heading. Calibration will eliminate such influences, and ensure Ace One system performs well in a non-ideal magnetic environment.

■ When to do it?

- 1 The first time you install Ace One on your helicopter.
- 2 When the helicopter mechanical setup is changed:
 - a) If the GPS module is re-positioned.
 - b) If electronic devices are added / removed / re-positioned (MC, servos, batteries, etc).
 - c) When the mechanical structure of the helicopter is changed.
- 3 If the flight direction appears to be shifting (meaning the helicopter doesn't "fly straight").
- 4 The LED indicator often indicates abnormality blinking when the helicopter yaws. (It is normal for this to happen only occasionally.)

■ Calibration procedure:

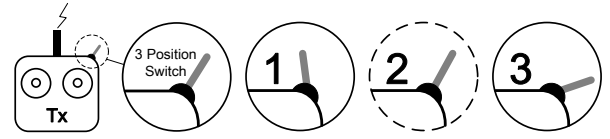

- STEP1:** Enter calibration mode: quickly slide the control mode switch from **Position-1** to **Position-3** for 10 times, and LED indicator will be constantly on in blue;
- STEP2:** Calibration in horizontal: rotate you helicopter along with the horizontal surface until the green light is on constantly, then go to the next step;
- STEP3:** Calibration in vertical: while green light is constantly on, hold your helicopter vertically and rotate it along with its vertical axis, keep rotating until the green light is off, meaning the calibration is finished.



- STEP4:** After you finished the calibration, LED indicator will show whether the calibration was successful or not:
- If white light turns on for 3 seconds, calibration succeeds, calibration mode will **auto exit**;
 - If red light keeps blinking quickly, the calibration has failed. Slide the control mode switch one time to cancel current calibration, and then re-start from step 1 for re-calibration.

- 1 Don't calibrate your compass where there is strong magnetic interference, such as magnetite, car park, and steel reinforcement under the ground.
- 2 DO NOT carry ferromagnetic materials with you during calibration, such as keys or cell phones.
- 3 You don't need to rotate your helicopter on a precise horizontal or vertical surface, but keep at least 45° difference between horizontal and vertical calibration.
- 4 Ace One cannot be work in the polar circle.



If you keep having calibration failure, it might suggest that there is very strong magnetic interference around the GPS, please avoid flying in this area.

C2 MANUAL MODE Test Flight



- 1 When the system is powered on, DO NOT move your helicopter or sticks on transmitter until the system initialization is finished (about 5 seconds).
- 2 Don't switch to **Atti. Mode**, **GPS Atti. Mode** and **GPS Cruise Mode** during **Manual Mode Test Flight**. Go through this section first, and read about how to do **Autopilot Test Flight** on **Page 24**.



- 1 Fly the helicopter. Trim transmitter such that the helicopter hovers stably.
- 2 You have to adjust the following parameters to achieve the best performance of your helicopter.
 - **Flybarless** parameters, if you've enabled Flybarless, see **Page 13** for details.
 - **Tail Gyro** sense, see **Page 15** for details.
 - **Engine speed**, if you are using Gasoline / Nitro engine, see **Page 16** for details.
- 3 Adjust Pitch curve on transmitter, so that the helicopter hovers at about mid-stick.
- 4 Set correct fail safe output on all channels of your R/C Transmitter/Receiver.
- 5 Verify Fail safe output of your transmitter on status bar in Ace One Assistant. **IMPORTANT!** The Enhanced Fail-Safe (Auto Hovering and Auto Go-Home) has not been activated yet, go through this section first and read about how to activate it on **Page 23**.



- STEP1:** Check all the connection and wiring connected firmly, and make sure they are in good condition;
- STEP2:** Make sure your batteries are fully charged for your transmitter, Ace One and all the devices on your helicopter;
- STEP3:** Turn on the transmitter first;
- STEP4:** Power on the Ace One and all the rest of electric devices on helicopter, except brushless motor controller;
- STEP5:** Check the LED indicator on GPS, if red LED blinks quickly & continually, then system start-up has failed; you have to place your helicopter horizontally and power on again. See Appendix for details about LED indicator;
- STEP6:** Slide the control mode switch on your transmitter to make sure it is working properly. Check LED indicator to specify the current working mode for Ace One. See Appendix for details about LED indicator;
- STEP7:** Others system failure and error will also be displayed by LED indicator on GPS, See Appendix for details;
- STEP8:** If everything checked, and without any problems, switch the system to **Manual Mode**, move all the sticks on your transmitter to check whether the helicopter is correctly responding to your commands;
- STEP9:** Start the engine or power on the brushless motor controller;
- STEP10:** Take-off and fly your helicopter in **Manual Mode**, before switching to other modes.

C3 Enhanced Fail-Safe

Ace One can detect the fail safe output from your receiver, if you have pre-set fail safe output correctly. Once your helicopter lost signal from the transmitter, Enhanced Fail-Safe function will control the helicopter automatically and save it in most of the conditions.

- 1 The Enhanced Fail-Safe (Auto Hovering and Auto Go-Home) will not be activated, until you've correctly Pre-set Transmitter Command Stick Center Position.
- 2 The Enhanced Fail-Safe functions will not be working correctly if you have not finished the **Auto Mode Test Flight**. Please see **Autopilot Test Flight** on **Page 24** for details.
- 3 You must perform the following setting under **Manual Mode**.
- 4 If GPS signal reception is bad, Auto Go-Home function will not be disable, even it was activated in Ace One Assistant, in case the Attitude Hold function will be force to activate instead.

 In Ace One Assistant Software, page-Enhanced Failed-Safe:

ENHANCED FAILED-SAFE

You have to do Tx Calibration before setting here!

TX Center Position STEP3

	current position	Confirmed
T	<input type="text"/>	<input type="text" value="0"/>
A	<input type="text"/>	<input type="text" value="0"/>
E	<input type="text"/>	<input type="text" value="0"/>
R	<input type="text"/>	<input type="text" value="0"/>
P	<input type="text"/>	<input type="text" value="0"/>

Please set this carefully, otherwise enhanced failed-safe function would not working as we designed. You will not be able to use Go-Home feature if the Tx center position setting has not been confirmed.

I have confirmed the TX center position STEP4

Enhanced Failed-Safe Methods STEP5

Hovering Go-Home (Return to Home)

STEP1: Please configure your autopilot to the best condition, make sure the helicopter can flight well under **GPS Cruise Mode and GPS Atti. Mode**;

STEP2: Switch your Ace One into **Manual Mode**;

STEP3: Please record your command stick positions which are the same as the moment you switched from **Manual Mode** (if you changed throttle curve before switching, use that curve for this setting). You will be asked to configure your transmitter, and let your helicopter able to hover with transmitter command stick roughly (Not to be exact) on their center position. You can read the **[current stick position]** which shown as number -1000 to +1000 in real time, click  button, save them into **[Confirmed]** group as Tx center position.

 You will be noticed by  symbol instead of  button, which means you throttle working range has not been correctly set or your throttle position is holding on throttle-cut (STOP) position. Please check your throttle-cut switch and throttle working range setting in Ace One Assistant page-Engine. See page16 for details.

STEP4: Must check the confirm box that the Tx center position is correct, otherwise enhanced failed-safe will be disabled.

STEP5: Select protection method, auto Hovering or Go-Home, the following schematic shown is introduction for Go-Home.

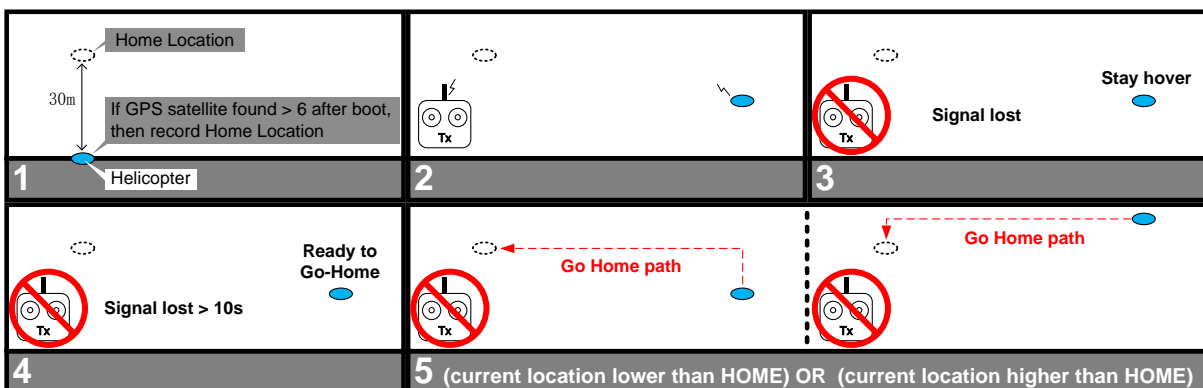

 Fail-Safe functions are designed for **GPS Atti. Mode and GPS Cruise Mode**. Once the helicopter came back to the available transmitter signal range, switch to **Manual Mode** then you can re-gain the control right for Ace One system.

C4 Autopilot Test Flight

 When system is powered on, you must not move your helicopter or sticks on transmitter until the system initialization is finished (about 5 second).



Please read this section before you switched to *Atti. Mode, GPS Atti. Mode and GPS Cruise Mode*

- 1 Make sure the GPS signal is good, without red LED blinking.
- 2 Please avoid using Ace One system in the following areas, where will GPS signal is most likely blocked:
 - Urban area with crowded buildings
 - Tunnels
 - Under bridges
- 3 Make sure the attitude of helicopter is in good condition, without white LED blinking.
- 4 Others system failures and errors will also be display by LED indicator on GPS/Compass module, See Appendix for details.



Optional Chargeable Function

■ **Semi-Auto take-off**

Please setup **B7 Engine Governor** and all center positions correctly before you use this function. On **STEP12**, the system can perform **Semi-Auto take-off** feature rather than manual take-off. Please follow the operation procedures strictly:

- 1 Put the throttle stick on the lowest position;
- 2 Switch to **GPS Cruise** or **GPS Atti.** or **Atti. Mode** and wait **until the speed of main rotor is stable** ;
- 3 Requiring only pushing the throttle (collective pitch) stick gently to take-off the helicopter, autopilot system will be in charge of the cyclic pitch/roll stabilization.

■ **Semi-Auto Landing**

In **GPS Cruise** or **GPS Atti.** or **Atti. Mode**, with throttle (collective pitch) stick operation only, descend the helicopter and hold throttle stick on lowest position until the engine or electric motor is cutoff automatically. This throttle idle or shut-down in Auto mode when collective is lowest stick position only applies having this option.



- 1 With this option, MC will perform in **GPS Cruise** or **GPS Atti.** Or **Atti. Mode** for both takeoff and landing. Please be aware this "Always on" auto mode should "NOT" be used in MC without this option.
- 2 Make sure use this function only when the GPS signal is sufficient and at open area!

STEP1: Check all connections and wirings, and make sure they are in good condition;

STEP2: Make sure your batteries are fully charged for your transmitter, Ace One and all the devices on your helicopter;

STEP3: Turn on the transmitter first;

STEP4: Power on the Ace One and all the rest of electric device on helicopter, except brushless motor controller;

STEP5: Check the LED indicator on GPS/Compass module, if red LED sparks quickly, the system start-up has failed. You will need to place you helicopter horizontally and power on again. See Appendix for details about LED indicator;

STEP6: You may find red LED blinking, indicating that Ace One is getting GPS satellite signal, please wait until red LED is off, meaning Ace One have found more than 7 GPS satellites, and that it can work in its best condition. See Appendix for details about LED indicator;

STEP7: Slide the control mode switch on your transmitter to make sure it is working properly. Check it with LED indicator to specify the current working mode for Ace One. See Appendix for details about LED indicator;

STEP8: Switch the system to **GPS Cruise Mode** or **GPS Atti. Mode**, if the swashplate is not horizontal, please go back to 3rd step, and power cycle the system;

STEP9: Switch the system to **Manual Mode**, move all the sticks on your transmitter to check whether the helicopter is correctly responding to your commands;

STEP10: If everything checked, and without any problems, switch the system to **Manual Mode**;

STEP11: Start the engine or power on the brushless motor controller;

STEP12: Take-off and fly your helicopter in **Manual Mode**;

STEP13: Hover your helicopter, and switch to **GPS Cruise Mode** or **GPS Atti. Mode**.



Do NOT move any stick when switching!



Should you find the helicopter does not track straight in forward flight, you might try re-mounting GPS in an offsetting angle as showed in right figure. Θ in the figure is the offsetting angle.

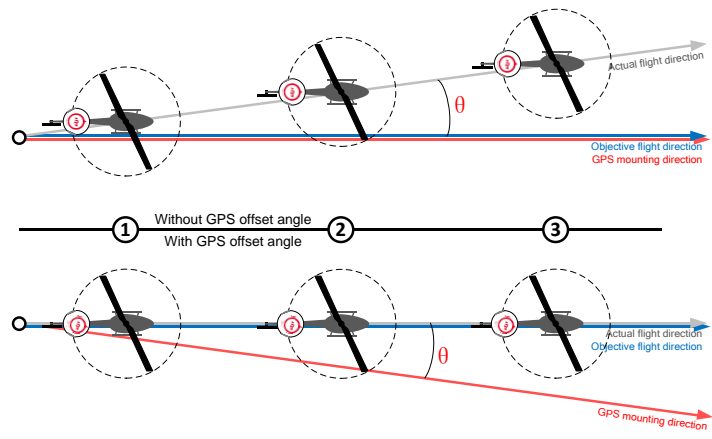

Maintains

Flight Log Reading

Notice: You may be asked to provide your Ace One Flight Log for customer support.

1. Click **[TOOL]** → **[Read Flight-Log]**.
2. Click **[OK]**.
3. Ace One Assistant Software will be closed automatically and Ace One MC will be working as a storage drive named **[ACEONE LOG]**, you can find it in **[My Computer]** directory.
4. Open it and you can find your flight log files there. Copy or delete as you do normal PC operations.
5. Please power cycle Ace One for exit from Flight Log reading mode.

 You have 4GB memory space for Ace One flight log recording.
If the memory is out of space, Ace One will stop flight log recording and format all the information after power cycle the MC.

Firmware Upgrade

Please strictly follow the operation procedure for firmware upgrade, otherwise Ace One might not work properly:

1. Make sure your computer is connected to the Internet.
2. Please close all the other applications during the firmware upgrade, including Anti-virus software and firewall.
3. Make sure the power supply is securely connected with Ace One. DO NOT un-plug the power supply until firmware upgrade has finished.
4. Connect Ace One MC to PC with micro-USB cable, DO NOT break connection until firmware upgrade is finished.
5. Open Ace One Assistant Software and wait for connection.
6. Select **[TOOL]** → **[Firmware Upgrade]**.
7. DJI server will check your current firmware version, and get the latest firmware prepared for Ace One Assistant.
8. If there is a firmware version more up-to-date than your current version, you will be able to click the upgrade button.
9. Wait until Ace One Assistant reads “Finished”.
10. Please power cycle Ace One after at least 5 seconds.
11. Your Ace One is up-to-date now.



- After firmware upgrade, please re-configure the Ace One via Assistant Software.
- If it is notified that the network or DJI server is busy, please try again later with above procedures.
- If firmware upgrade failed, the Ace One will enter **<waiting for firmware upgrade status>** automatically, please try again with the above procedures.

Product Info

You can check the Ace One product version via **[ABOUT]** → **[Info]**.

- Software version
- Firmware version
- IMU version
- Hardware ID

[S/N] is a 32 digits authorization code for Ace One function activations. We had already filled in the authorization code for your Ace One after manufacture. You might be asking to fill in the new **[S/N]** in the future if you brought new function upgrades.

Fill-in the **[S/N]** and then click **[Write]** button.

 If you filled in the invalid S/N over 30 times, your Ace One will be locked and you have to contact our customer support.

Product Specifications

■ **General specifications**

Built-In Functions:	Autopilot Tail Gyro Engine Governor Flybarless Return-to-Home Fail Safe
Helicopter Types:	Electric and internal combustion powered
Supported Swashplate Types:	Normal, Three Servo 120°/140°/90°, Four Servo 90°
Supported Servo output:	500Hz (760us) /200Hz (1520us) for Rudder Channel; Others follow on your receiver output.
Recommended Transmitter:	PCM or 2.4GHz with minimum 7 channels and Failsafe function available on all channels
Recommended Power Supply:	DC 7.4~8.4V (Not to exceed MAX operating voltage of servo motor) > 4000 mAh capacity, Discharge current more than 5C
Power Consumption:	MAX 5W (0.9A@5V, 0.7A@5.8V, 0.5A@7.4V, 0.4A@8V)
Operating Temperature:	-5°C to +70°C (You have to keep the IMU warm if you want to use it under low temperature, could be -10°C even lower.)
Memory:	4GB Flash Memory for flight information recording

■ **Flight Performance (can be effected by mechanical performance)**

Hovering Accuracy:	Vertical : ± 0.5m Horizontal : ± 1m
Suitable Wind Condition:	< 8m/s (17.7mph)
Forward / Backward Speed:	± 72 Km/h (44.74mph)
Left / Right Speed:	± 56.7 Km/h (35.77mph)

■ **Packaging & Shapes**

Total Weight:	<= 150g
Dimensions:	Main Controller: 61mm x 39.6mm x 15.8mm IMU: 40mm x 31mm x 26mm GPS & Compass: 50mm (diameter) x 9mm